

# DISCFLO

PUMPS

DISCFLO

CONNECT WITH US

+1.619.596.3181

sales@discflo.com

10850 Hartley Rd., Santee, CA 92071

www.discflo.com



OIL & GAS + PETROCHEMICAL

## INTRODUCTION

Hydrocarbon production, specifically for heavy and extra heavy crude oil, is becoming more complex due to the fluids' characteristics, conditions, and physicochemical properties that impede extraction, so various techniques have been used for exploitation. This is also causing a switch in the equipment used to pump these viscous fluids from underground, to the surface or to the final destination where they will be treated.

The problems and limitations presented by crude oil displacement equipment have spurred the development of Rotodynamic and positive displacement pumps, which cover the basic requirements of the industry. But every day, these technologies are threatened with being displaced by equipment with greater efficiencies that present less wear caused by the action of the fluid and optimize oil production at the lowest possible economic cost.

**In this complex industry, hydraulic disc pumps have great advantages compared to other types of pumps. Experimental studies and field tests show that the hydraulic disc pump, manufactured by the American company Discflo Corporation, is a viable solution for viscous fluids pumping (crude oil) and multiphase flow (gas—liquid—solid) due to its pumping mechanism, which is based on the effect of *boundary layer and viscous drag*.**

## DISCFLO PUMPS STREAMLINE **MULTI-PHASE FLOW**

(HEAVY CRUDE OIL - WATER - GAS - SAND)  
**REPLACEMENT OF TWIN-SCREW PUMPS  
CAMPO QUIFA - COLOMBIA**

Due to the presence of heavy crude oils (8-15° API) in the basins of the Eastern Plains from the Colombian Quifa field, the operational conditions of the crude pumping station were a challenge for the traditional applications of positive displacement pumping using Twin-screw Pumps. The presence of solids, sand, water and other pollutants typical of the crude oil in this field, as well as entrained gas and very large viscosity ranges bound together the most undesirable conditions for a traditional screw pump. The continuous wear of the screws and mechanical seals required a halt in production to replace parts which generated high life cycle costs. The result, a high economic impact on the operation and sustainability in this pumping station.

Our Discflo pumps have high tolerance to solids, entrained gas, broad ranges of viscosity (water, light crude oil, medium crude oil, heavy crude oil and extra heavy crude oil), and lower requirements of NPSH. Based on our pumps technology, the replacement of the twin-screw pumps by Discflo increased pumping capacity and system efficiency while reducing downtime and the overall costs in the life cycle for this application.

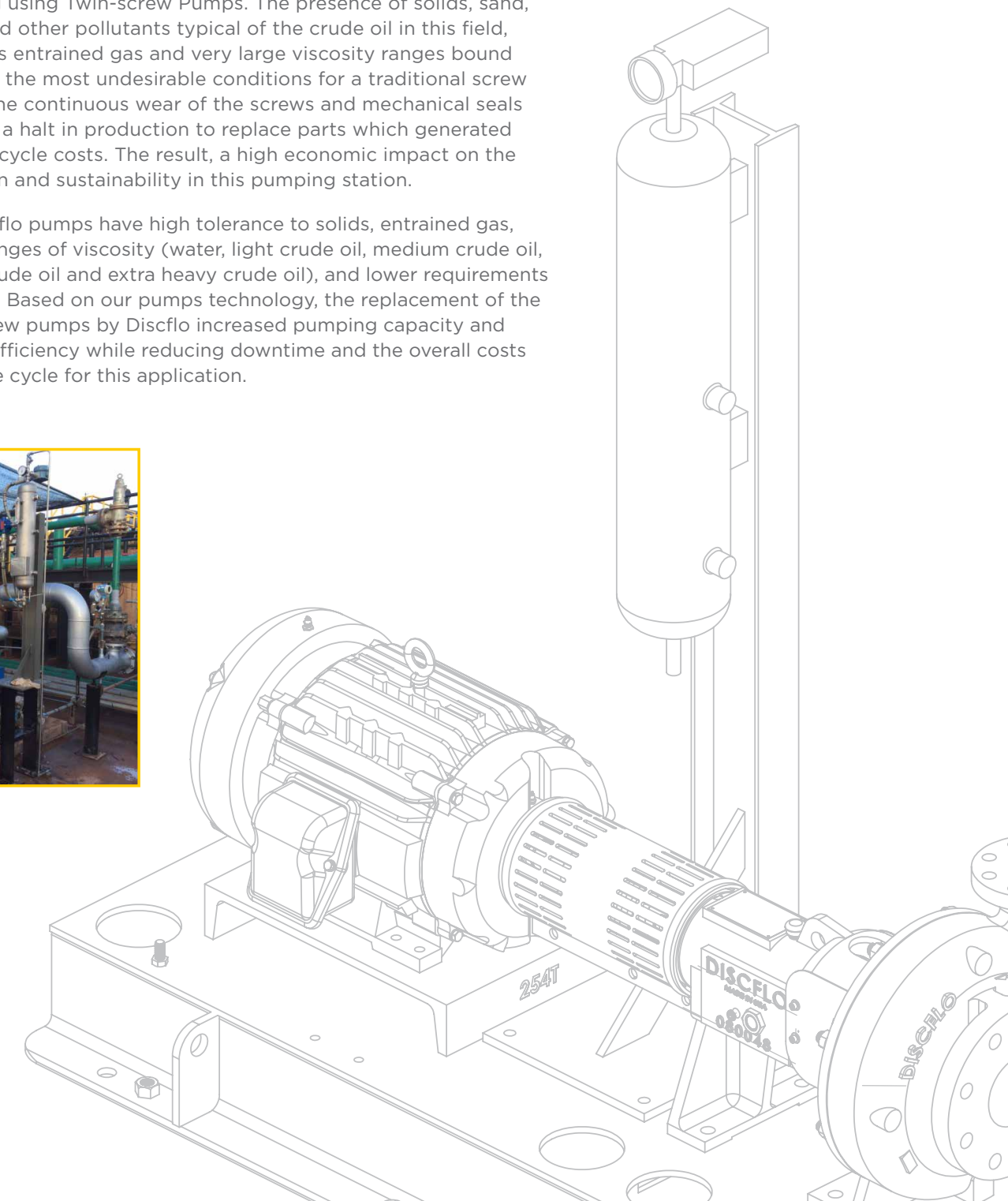

# WHAT OUR CUSTOMERS ARE SAYING

## ZERO DOWNTIME FOR OIL SLUDGE PUMP

“Sometimes, it is viscous as water and at other times as much as 1000cP. The disc pump’s ability to handle variations in viscosity without breaking down was one of the key factors for choosing the Discflo design.”

**Challenge:** 400GPM/465TD/10-20%/solids/  
Viscous/Abrasive/Frequent Pump Failure



## “GODSEND” FOR DREDGING

“Our company selected Discflo because of its ability to handle highly viscous product and provide the volume needed, together with its durability and lack of maintenance.”

**Challenge:**  
Viscosity 20,000\_cPs/Solids 2-40%/Filter  
press cycle time 90 minutes



## SOLVING OIL EMULSION PUMP PROBLEMS

For 40 years moving slop oil has become “a reliability nightmare” with over 30 maintenance work orders in a year.

**Challenge:**  
Emulsifying oil in transfer. Changes in fluid  
conditions causing pump breakdowns.  
Loss of performance due to abrasive wear.

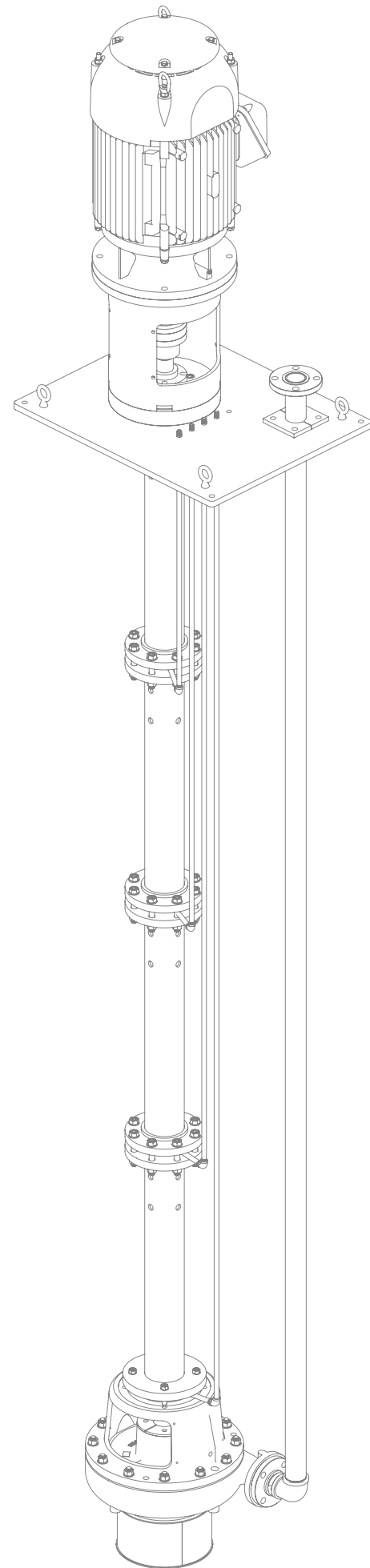

SUBMERSIBLE PUMP | NORTH SEA | DRILLING MUD WITH CUTTINGS

Discflo’s pumps have been solving problems in the Oil & Gas + Petrochemical, offshore and onshore service, subsea operations, tank transfer, environmental clean-up operations, crude oil processing and pumping oil/water emulsions industry for over 36 years. The powerful combination of superior abrasion resistance, gas entrained pumping ability, and non-emulsifying laminar flow make the disc pump the ideal choice for some of the toughest applications.

## APPLICATIONS WE SUCCESSFULLY PUMP:

- ABRASIVE AND/OR CORROSIVE FLUIDS
- CRUDE OIL
- DRILLING MUD
- HEAVY OIL
- HIGH-SOLID FLUIDS TO 70% SOLIDS
- HIGH TEMPERATURE/PRESSURE
- LARGE AND STRINGY SOLIDS UP TO 8” IN DIAMETER
- MULTI-PHASE FLUIDS (GAS, LIQUID, SOLID)
- OIL/WATER EMULSIONS
- PETROLEUM BASED SLURRY
- PRODUCED WATER
- RAW CRUDE AFTER SEPARATION
- SAND, OIL, WATER TOLUENE
- SEA WATER/CUTTINGS
- SLUDGE (WASTE/TO COKER)
- SULPHUR
- TRANSFERRING CRUDE OIL
- VISCOUS SLURRIES TO 70,000 cP
- WASTE POND SLUDGE (W/ENTRAINED GAS)



# DISCFLO ADVANTAGES

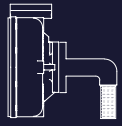

**NO PULSATION**

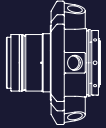

**LONGER SEAL LIFE**

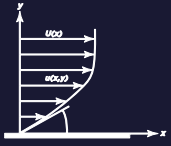

**LAMINAR FLOW**

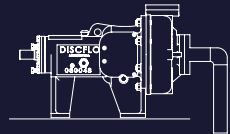

**HIGH SUCTION LIFE CAPABILITY**

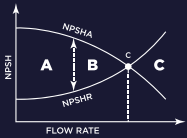

**VERY LOW NPSH**



**EXCELLENT MEAN TIME TO REPAIR (MTTR)**

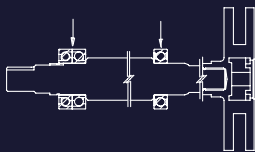

**NO RADIAL LOAD**



**EXCELLENT MEAN TIME BETWEEN FAILURE (MTBF)**

**Non-impingement** pumping, laminar, pulsation-free flow offers the best protection for shear-sensitive products and ensures pump longevity.

**No close tolerances** or loss of performance due to wear

**Open design** prevents clogging, so pump can handle large or stringy solids, as well as fluids with varying solids content, size or viscosity.

**Low NPSHr**—about a third to a half less than a comparably sized centrifugal pump

**Increasing efficiency** as fluid viscosity increases due to the viscous drag pumping principle

**Low wear** even in abrasive service due to the laminar flow and non-impingement pumping

**Exceptional reliability** due to rugged construction and solids handling capability

**Very few spare parts** required (less than 5% of company revenue comes from parts sales)

**Runs Dry Indefinitely** Provided seal must be protected

**Hydraulic flow capacities:** 1-8000 GPM

**Differential pressures:** Up to 433 psi

**Discpac diameters:** 1.75" - 24"

**Working pressures:** Up to 2500 psi

**Operating temperatures:** Up to 1000°F

**Viscosities:** Up to 70,000 + cP

**Solids size (max):** 8"

**Pump speeds:** 3600 + rpm

Discflo's Disc Pumps have been solving the pumping problems of the oil industry for over 36 years. The powerful combination of superior abrasion resistance, gas-entrained pumping ability, and non-emulsifying laminar flow make the Disc Pump the ideal choice for some of the toughest applications. **Worldwide.**



# HEAVY CRUDE OIL SEPARATION PLANT

Heavy Crude Oil + Water + Gas

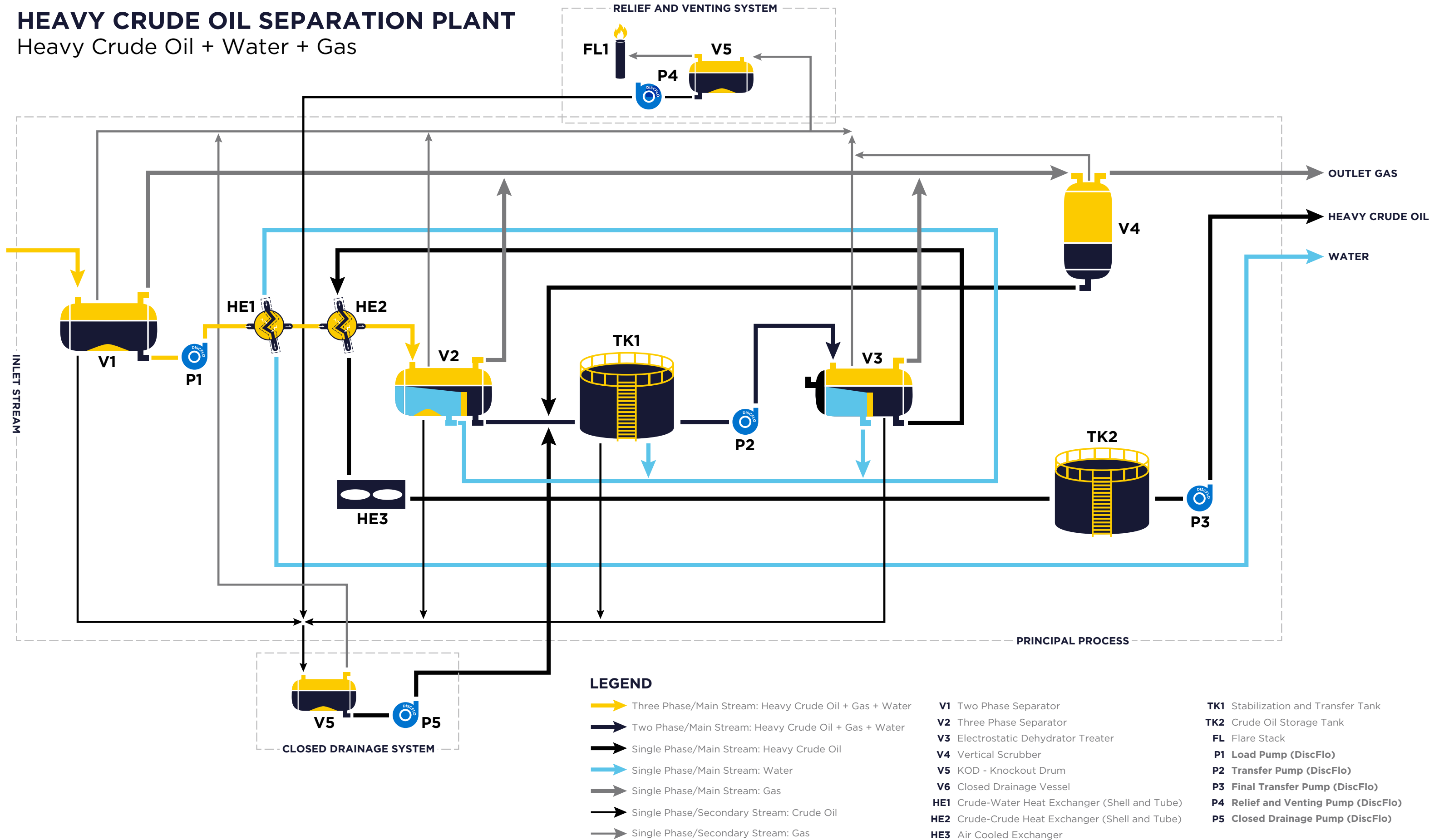

STAGE  
1



## HEAVY CRUDE OIL PLANT:

In heavy crude oil production operations it will always be necessary to transport viscous fluid from one place to another in the different processing stages. To energize it within a separation station there are well-defined applications:

- Load pumps & Transfer pumps
- Separated and dehydrated crude transport to the storage tanks
- Closed drainage systems
- Open drainage systems
- Relief and venting systems

STAGE  
2



## DRILLING OPERATION:

In the drilling process, Discflo can solve many problems related to the handling and transport of drilling mud and fluids. In the Solids control systems we have applications in:

- Vertical pumps for feed of centrifuge
- Pumps for desander feed
- Degassing pumps
- Submersible pumps for the eviction of drilling mud waste, etc.

STAGE  
3



## TANK FARM:

Discflo has direct applications in pumping and transporting heavy crudes in:

- Between tanks belonging to a tank farm
- From tank farms to refineries through oil pipelines
- From tank farms to marine terminals
- From tank farms to other tank farms

STAGE  
4



## OIL REFINERY:

Discflo has a presence with many applications, among which we can mention:

- Discharge pump in heavy waste streams
- Pumps in drainage and condensate systems
- Pumps in the Relief and Venting System
- Submersible pumps for emptying oxidation ponds
- Pumps in industrial water treatment plants

STAGE  
5



## MARINE TERMINAL:

For the transport of heavy crudes in marine terminals, Discflo has the following applications:

- Pumping from oil tankers to transfer buoys (unloading)
- Pumping from the marine terminal to refineries through oil pipelines.
- Pumping from the marine terminal to oil tankers. (loading)



# HARNESSING THE POWER OF BOUNDARY LAYER VISCOUS DRAG

The **non-impingement** and **laminar flow** pumping of the Disc pump is similar to flow through an ordinary pipe. The layers of fluid at the walls are stationary (relative to the rotating discs), creating a protective boundary layer. Viscous drag pulls layers into flows of smooth laminar streams.

### NO CLOSE TOLERANCES

The Disc pump is not a centrifugal pump, positive displacement, gear or lobe pump. Unique in design, the Disc pump bridges the performance gaps of conventional pumps and is capable of out-performing all of them in many applications.

### Non Pulsating, Laminar Flow

### NO RADIAL LOADS

The Disc pump uses a new and patented technology that isn't available in any other pump. The technology of the Disc pump harnesses the natural power of the boundary layer and viscous drag.

### NON PULSATING, LAMINAR FLOW

Through viscous drag, the fluid is pulled through the pump without impingement. The boundary layer attracts and drags successive layers of fluid molecules into layered flows of parallel streams. This is the simple principle of viscous drag and in the Disc pump it is a powerful dynamic force that "pulls" the fluid through the pump in a smooth laminar, non-turbulent flow.

With no impingement device to damage your product and a boundary layer of protection for the pump, the Disc pump effectively eliminates the root cause of clogging, cavitation, excessive wear and product damage that plague the performance of conventional pumps. Discflo is more reliable and efficient in handling tough application and a lot more cost effective. It simply lasts longer, requires fewer (if any) repairs and doesn't damage your product.

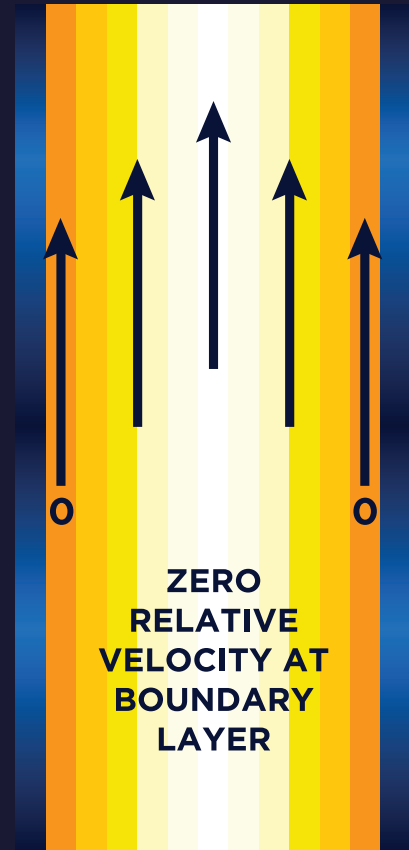

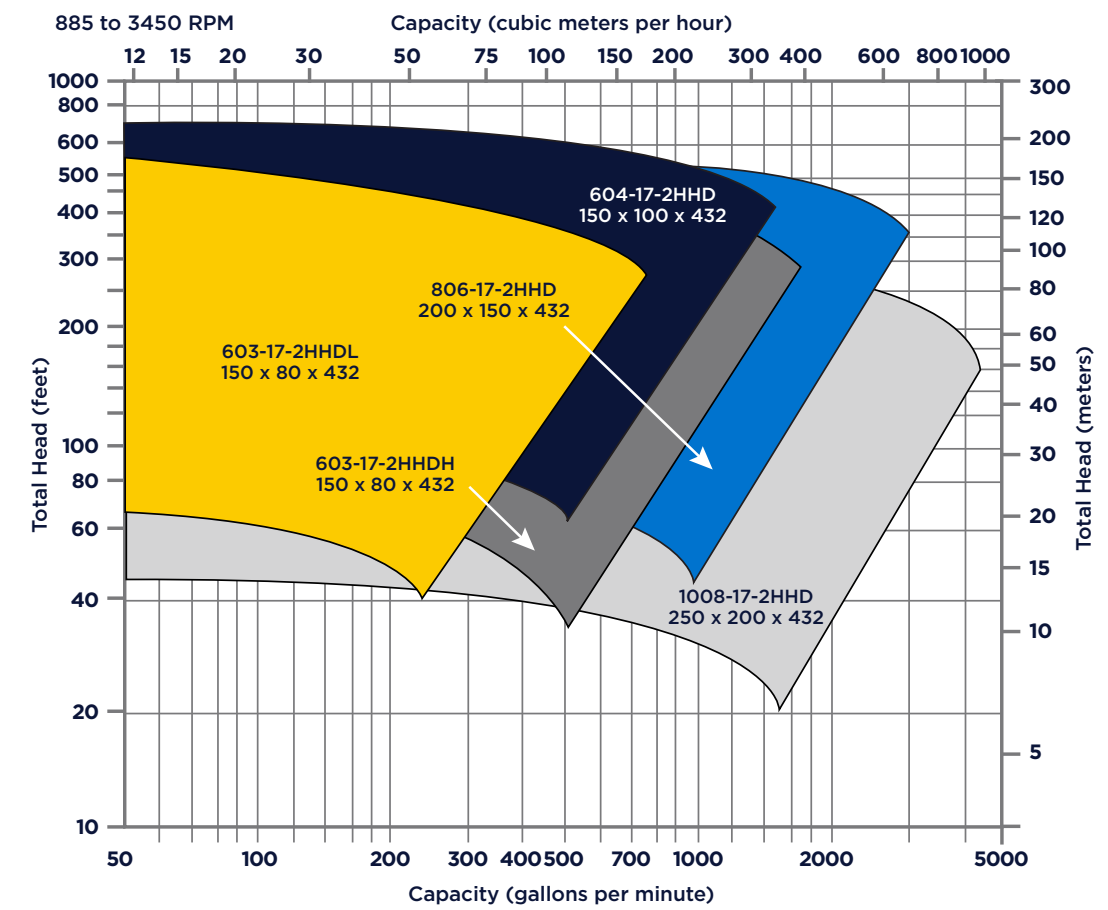
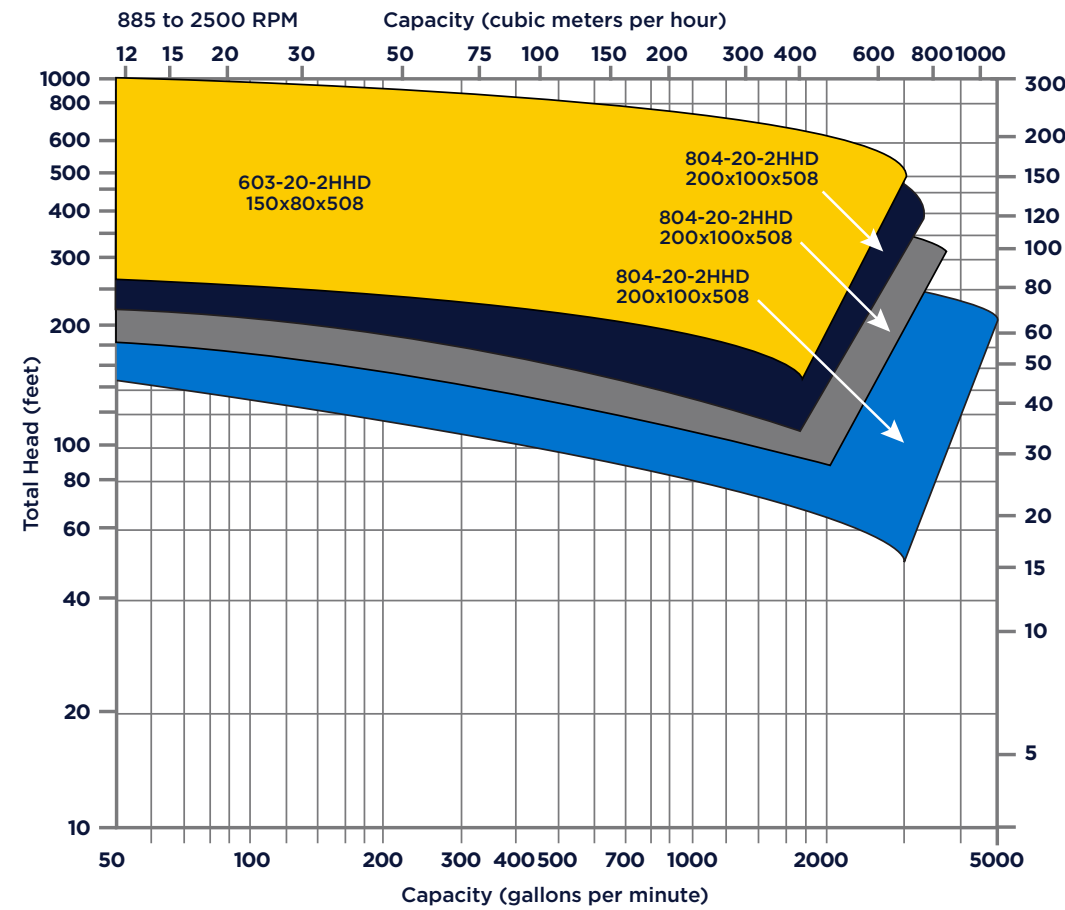
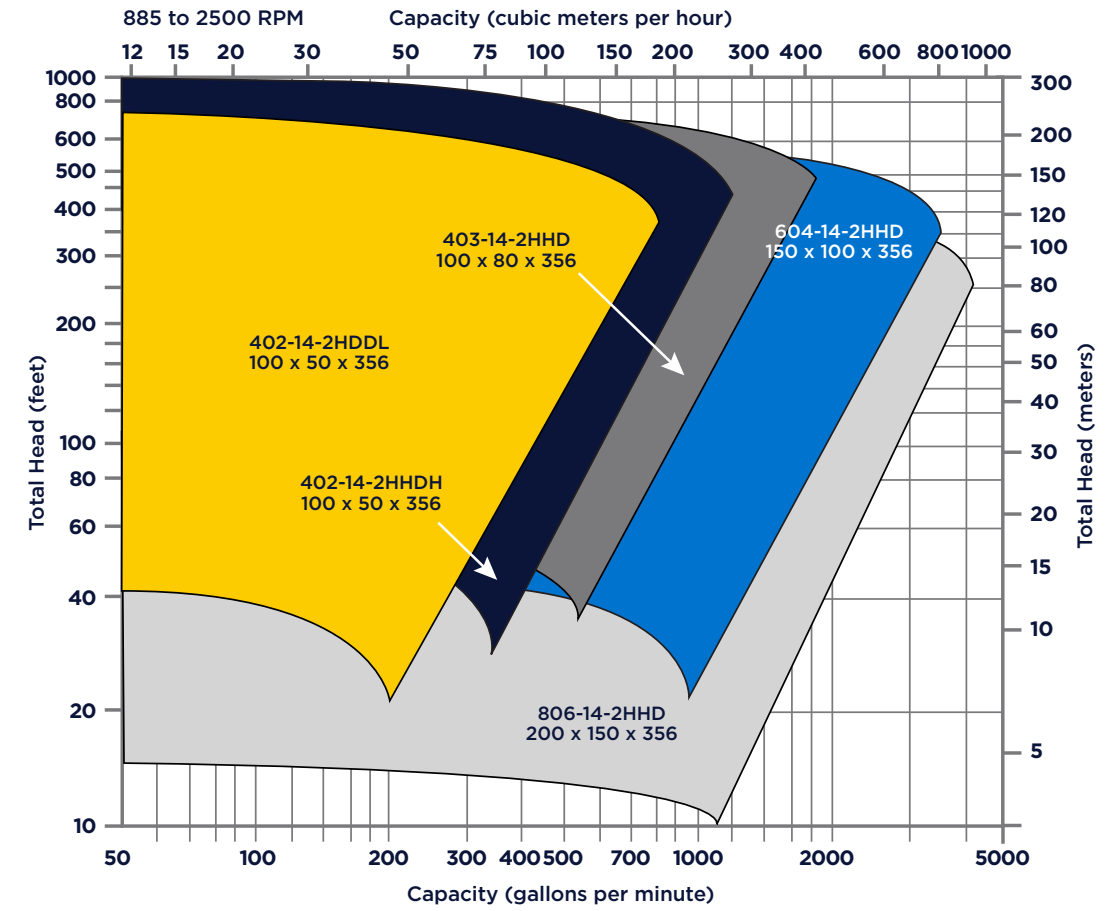
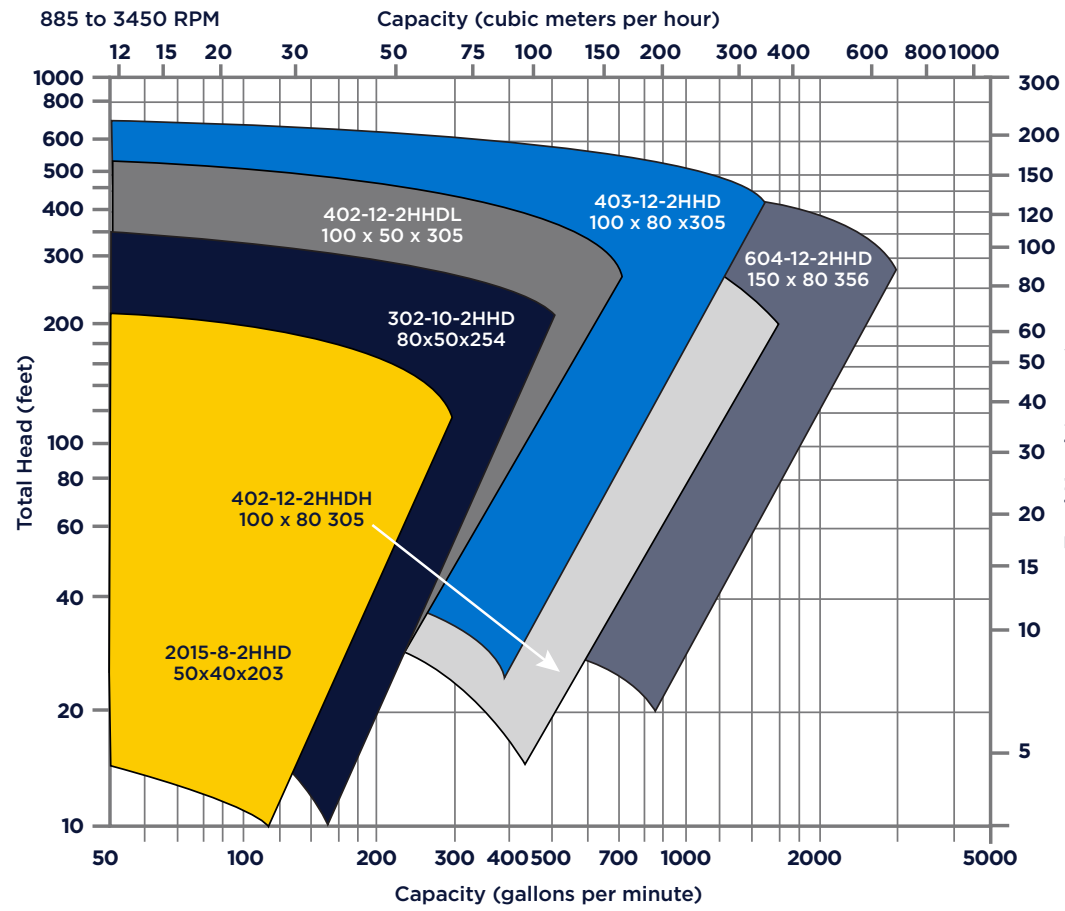

WE HAVE  
SUCCESSFULLY  
SERVED MANY OF  
THE TOP **OIL AND  
PETROCHEMICAL**  
COMPANIES IN  
THE WORLD

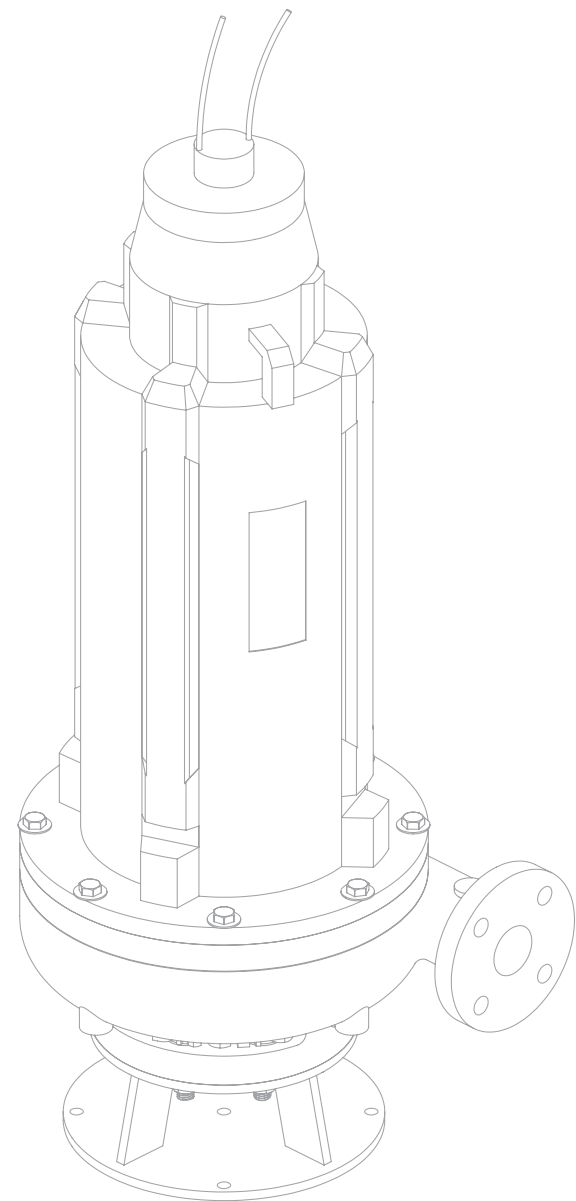

ARCO  
BRITISH PETROLEUM  
CHEVRON  
CITGO  
ENI PETROLEUM  
EXXON MOBIL  
GE  
HALLIBURTON  
MAERSK  
NORTHEAST  
PETROLEUM  
PACIFIC OIL & GAS  
PACIFIC RUBIALES  
PDVSA  
PEMEX  
PETROAMAZONAS  
REPSOL  
SAUDI ARAMCO  
SHELL  
STATOIL  
TEXACO  
TOTAL

At Discflo, our  
goal is to design  
and manufacture  
pumps which  
provide a long  
term solution  
for the toughest  
applications.  
**Worldwide.**



**DISC**FLO