

Fisher™ 377 Trip Valve

Fisher 377 pressure-sensing trip valves are for control applications where a specific valve/actuator action is required when supply pressure falls below a specific point. When supply pressure falls below the trip point (see figure 1), the trip valve causes the actuator to fail up, lock in the last position, or fail down. When the supply pressure rises above the trip point, the 377 trip valve automatically resets, allowing the system to return to normal operation. The trip valve can be top-mounted on a manifold, yoke-mounted, or bracket-mounted to match the application requirements. 377 trip valves can be used with Fisher 480, 585C, 685, 1061, 1066, 1069, and Bettis™ G Series piston actuators.



W4292-1

Features

- **Cost Effective**—Single trip valve construction reduces costs and spare part requirements of those systems using three separate switching valves to perform the failure functions. A single trip valve greatly simplifies piping requirements.
- **Ease of Mode Conversion**—Conversion to any of the fail modes requires only minor hookup changes.
- **Adjustable Trip Valve**—The trip point is adjustable for specific supply pressure requirements.
- **Reliable Operation**—The trip valve design includes large diaphragm areas and few moving parts for efficient performance, minimum maintenance, and long service life.



Fisher 377 Trip Valve Mounted on
Size 130 585C Actuator

W8435-1

Specifications

Available Configurations

When supply pressure falls below the trip point,
377D Trip Valve: Fails actuator piston down. Includes check valve and volume tank.
377L Trip Valve: Locks actuator piston in the last position.
377U Trip Valve: Fails actuator piston up. Includes check valve and volume tank.
377CW Trip Valve: Fails fully clockwise to close the valve. Requires check valve and volume tank. Trip valve moves piston to either up/down position and requires actuator configuration for actual clockwise movement.
377CCW Trip Valve: Fails fully counterclockwise to close the valve. Requires check valve and volume tank. Trip valve moves piston to either up/down position and requires actuator configuration for actual counterclockwise movement.
 All 377 trip valves can be converted to any of the above fail modes with minor hookup changes

Allowable Supply Pressure for Trip Valve⁽¹⁾

Maximum: 10.3 bar (150 psig)
 Minimum: 3.8 bar (55 psig)

Outlet Pressure⁽¹⁾

Normal Operation: Pressure from control device
Fail-Up or Fail-Down Mode: Maximum volume tank pressure
Lock-In-Last-Position: Respective cylinder pressure

Trip Point⁽²⁾

Adjustable from a minimum of 2.8 bar (40 psig) to a maximum of 72 percent of supply pressure; see figure 1
Reset: 12.5 to 33 percent above adjusted trip point

Flow Coefficients (C_v)⁽³⁾

Depends on flow path (shown in figure 3) as follows:
 Port A to Port B and Port D to Port E: 0.5
 Port B to Port C and Port E to Port F: 0.6

Body Connections

1/4 NPT internal

Temperature Capabilities⁽¹⁾

Nitrile Diaphragms and O-Rings: -40 to 82°C (-40 to 180°F)

Fluorocarbon Diaphragms and O-Rings: -18 to 104°C (0 to 220°F)

Volume Tank Maximum Internal Working Pressure (for 377D, 377U, 377CW and 377CCW trip valves)

Standard: 10.3 bar (150 psig) for non-ASME approved applications⁽⁴⁾
ASME Approved Applications: Rated 10.3 bar (150 psig), maximum; 9.3 bar (135 psig), recommended

Volume Tank Sizing

See sizing section

Note: Volume tank capacity values are nominal values only. Actual volume may vary slightly due to tolerances within the volume tank and supplier variability.

Hazardous Area Classification

Complies with the requirements of ATEX Group II Category 2 Gas and Dust



Maximum surface temperature (Tx) depends on operating conditions

Gas: T4, T5, T6
Dust: T85...T104

Meets Customs Union technical regulation TP TC 012/2011 for Groups II/III Category 2 equipment

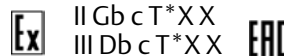

377 SST

Safety Instrumented System Classification
 SIL 3 capable - certified by exida Consulting LLC

Mounting

Top-Mounted: Manifold-mounted between a 3570 positioner and a 480 actuator (manifolds cannot be supplied with 585C, 685, 1061, 1066, and 1069 piston actuators)
Side-Mounted: Yoke-mounted or bracket-mounted for use with a FIELDVUE™ DVC6200, DVC6200f, DVC6200p, DVC6000, or DVC6000f digital valve controller

Specifications (continued)

Approximate Weight

Trip Valve

Aluminum: 0.95 kg (2.1 pounds)

Stainless Steel: 2.31 kg (5.1 pounds)

Mounting Manifold: 0.5 kg (1.2 pounds)

Volume Tank: Varies between 5.4 and 363 kg (12 and 800 pounds) depending on size

Construction Materials

Housing: ■ Aluminum or ■ Stainless steel

Cover: 25% mineral-filled thermoplastic polyester

O-Rings: Nitrile or fluorocarbon

Diaphragms: Nitrile or fluorocarbon

Interior parts

Aluminum construction: Brass, aluminum, steel, and stainless steel

Stainless Steel construction: Stainless steel

1. The pressure/temperature limits in this document and any applicable standard or code limitation should not be exceeded.
2. If the trip point is not specified, the trip point is factory-set at 72 percent of supply pressure or 2.8 bar (40 psig), whichever is higher.
3. Values represent nominal C_v measures for each port pair using a trip valve/actuator combination.
4. This tank is rated at 14.5 bar (240 psig) in LP service. When used with air, the rating should be considered to be 10.3 bar (150 psig), consistent with the maximum pressure allowed for the 377 trip valve.

Figure 1. Maximum Trip Point Settings

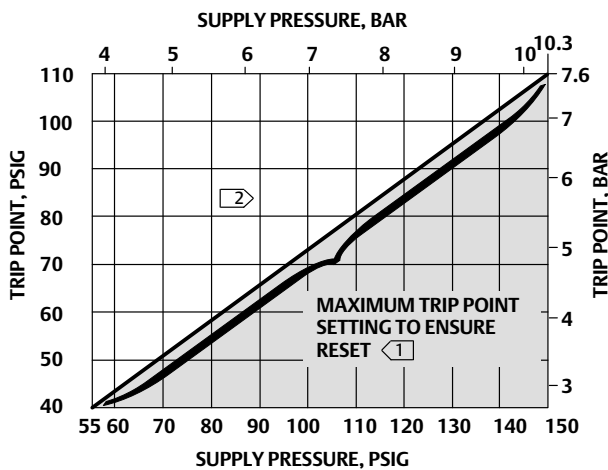

A2779-2

- 1 Trip point may be set to any value between 2.8 bar (40 psig) and the maximum trip point line.
- 2 Reset occurs a 12.5 to 33 percent above adjusted trip point.

Safety Certification

The 377 SST is certified for use in Safety Instrumented System (SIS) applications. Certification is by exida Consulting LLC, a global provider of functional safety and control system security (see figure 2). SIS certification is identified on the product by a label affixed to the pilot body.

The functional safety assessment was performed to the requirements of IEC 61508: ed2, 2010, SIL3 for mechanical components.

Figure 2. exida Certificate



Principle of Operation

377D Trip Valve

In normal operation, supply pressure loads the upper diaphragm (see figure 3) of the unit. The valve plug spring keeps the exhaust port closed. Supply pressure also loads the lower diaphragm through the restriction, causing the plug assemblies to move down and isolate ports C and F while connecting port A to B and port D to E.

Normal actuator control pressure flows from the control device to the top of the cylinder through ports A and B and to the bottom of the cylinder through ports D and E. A volume tank is charged to maximum supply pressure through a check valve in order to retain maximum supply pressure in the volume tank if supply pressure drops.

When supply pressure falls below the trip point pressure in the fail-down mode (see figure 4), the exhaust port opens, venting the supply pressure that is loading the lower diaphragm. This causes the upper ports of the plug assemblies to close and shut off normal pressure flow from the control device to the actuator.

Volume tank pressure then flows through ports C and B to the top of the actuator cylinder, while pressure in the bottom of the actuator cylinder is vented through ports E and F. The pressure imbalance created forces the actuator piston down.

Figure 3. Simplified Sectional View of Trip Valve

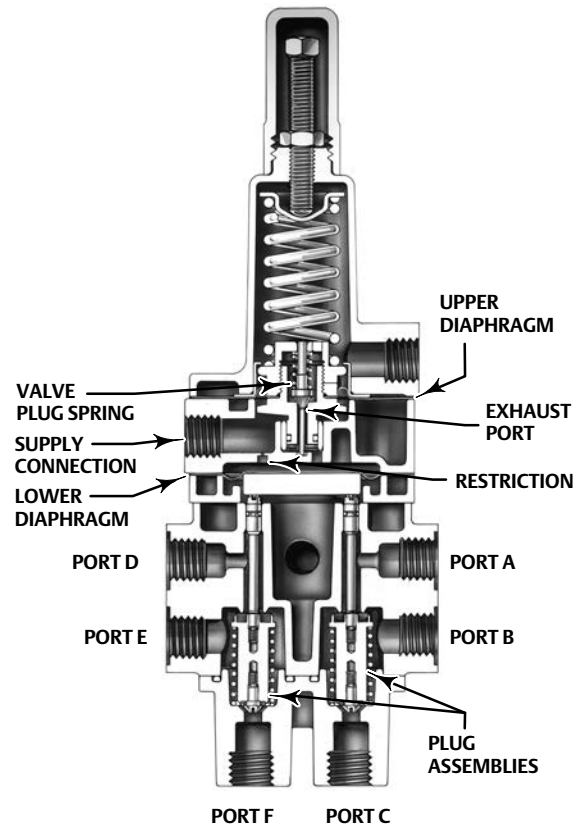

When supply pressure is restored, it loads the upper and lower diaphragms, causing the trip valve to reset. The exhaust port closes. The upper ports of the plug assemblies open, and the lower ports close. Normal actuator control pressure flow from the control device is restored through ports A and B and ports D and E. The check valve opens and recharges the volume tank to the maximum supply pressure.

Figure 4. Fisher 377D Trip Valve Shown Tripped

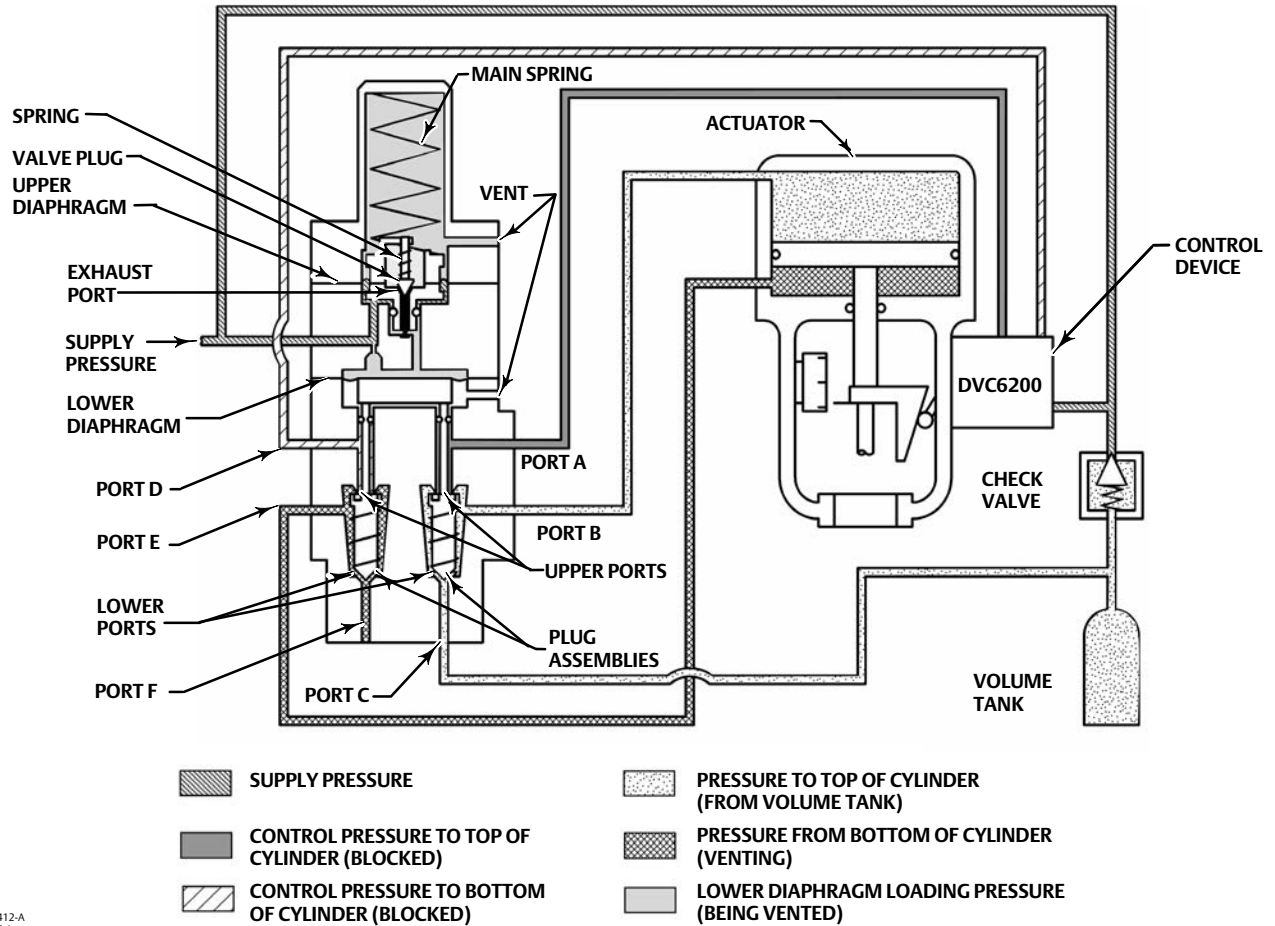

GE08412-A
A6905-1

Figure 5. Fisher 377L Trip Valve Shown Tripped

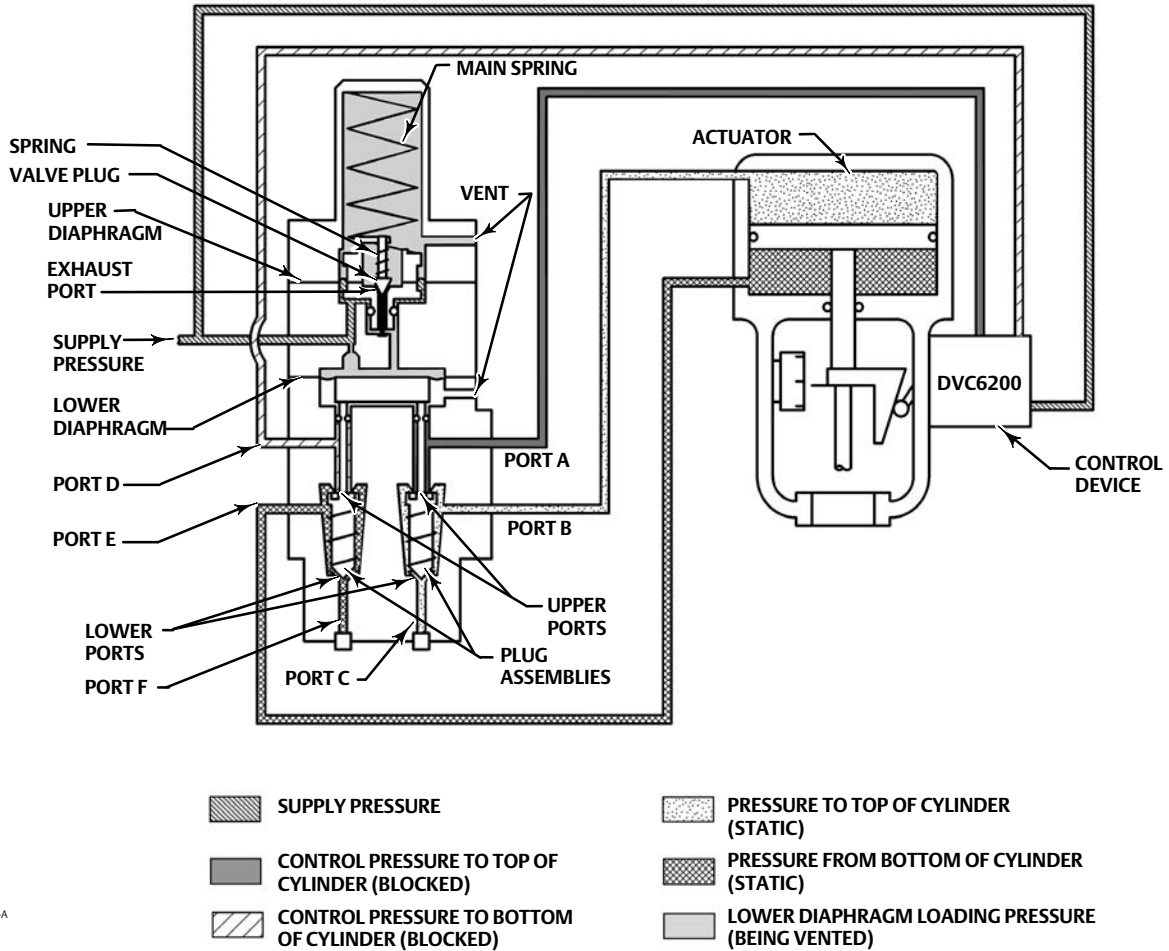

GE08414-A
A6906-1

377L Trip Valve

When supply pressure falls below the trip point in the lock-in-last-position mode (see figure 5), the exhaust port opens, venting supply pressure from the lower diaphragm. This causes the upper ports of the plug assemblies to close and the lower ports to open. Since ports C and F are plugged, no pressure change occurs

on either side of the actuator piston, and the piston is pressure-locked in position upon loss of supply pressure. No volume tank is necessary in this mode. When supply pressure is restored, the plug assemblies move back into the normal operating position, and supply pressure flows from the control device through ports A and B to the actuator.

Figure 6. Fisher 377U Trip Valve Shown Tripped

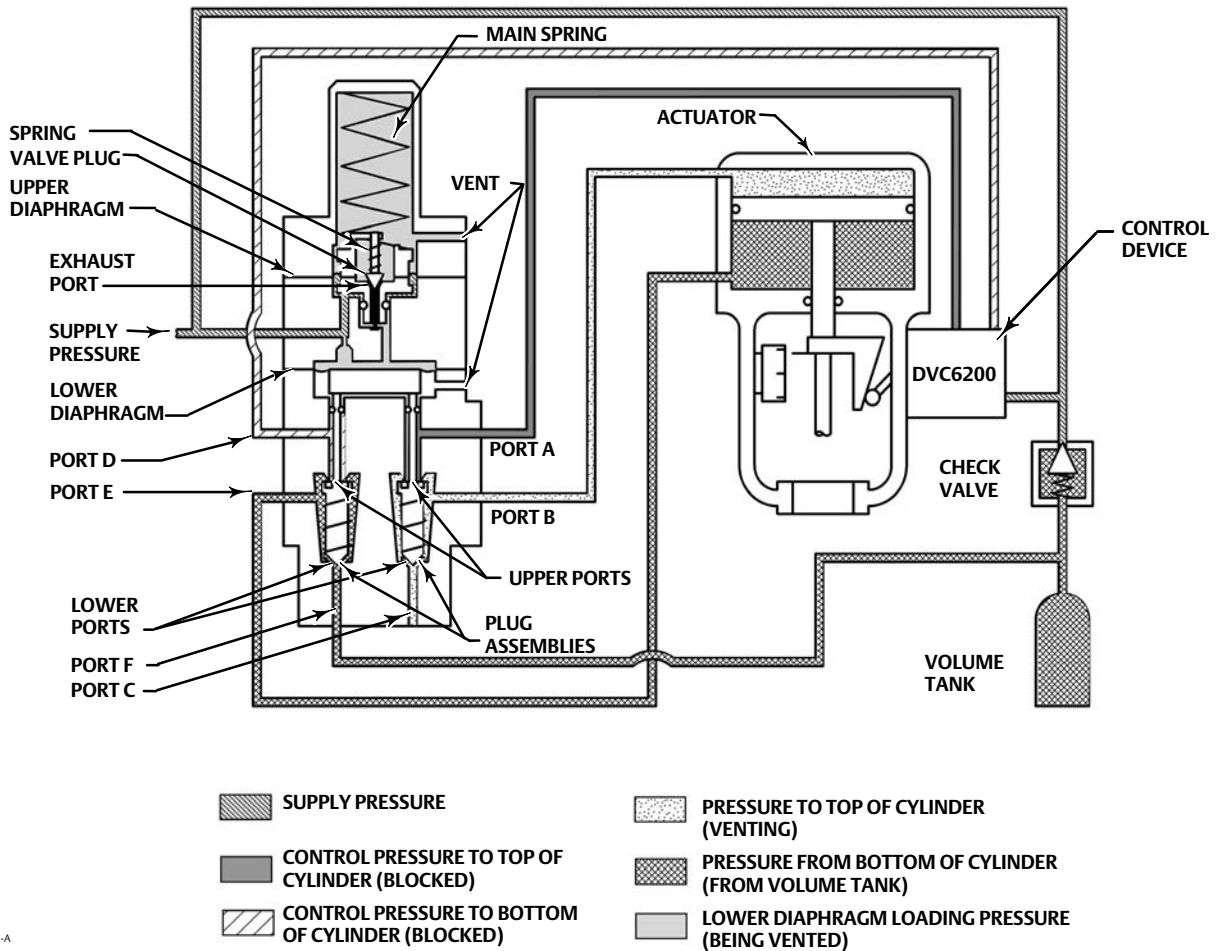

GE08413-A
A2284-6

377U Trip Valve

The fail-up mode of operation (figure 6) is similar to the fail-down mode of operation except that connections to port C and F are reversed. When supply pressure falls below the trip point, the top of the actuator cylinder vents, and volume tank pressure loads the bottom of the actuator cylinder. The pressure imbalance created forces the actuator piston up.

377CW and 377CCW Trip Valves

Makes use of the 377D or 377U trip valve configurations, a piston actuator, and volume tank with check valve to move the piston actuator to either the up or down position. Requires the actuator and valve configuration for actual clockwise or counterclockwise movement.

Volume Tank Sizing

Notes

State and local regulations may require the use of ASME-approved volume tanks. It is the user's responsibility to determine requirements and applicable regulations for proper volume tank selection.

Volume tank capacity values are nominal values only. Actual volume may vary slightly due to tolerances within the volume tank and supplier variability.

Several different tanks of varying capacities are available. The volume tank must be selected so that its pressure at any time is greater than the minimum percentage of maximum supply pressure required to stroke the actuator (see figure 7).

Figure 7. Volume Tank Sizing Graph

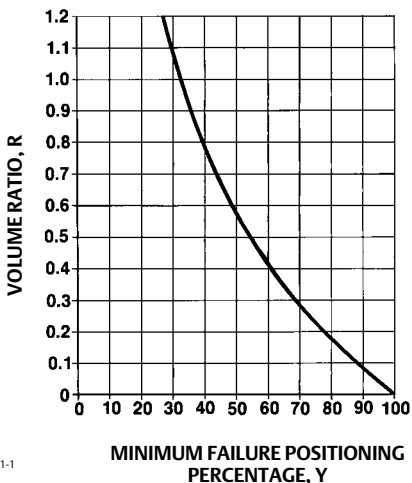

A2281-1

1. Size the volume tank as indicated below:

For Actuators on Sliding Stem Valves, Determine:

$$Y = F/AP \times 100$$

For Actuators on Rotary-Shaft Valves, Determine:

$$Y = P_r/P \times 100$$

Where:

Y = Minimum failure positioning percentage

F = Actuator thrust required in normal operation to position the valve at the desired limit of travel

A = Effective piston area (from the appropriate actuator bulletin)

P = Maximum supply pressure available

P_r = Highest pressure required by the actuator to stroke the valve (from the appropriate actuator sizing technique)

2. With the minimum failure positioning percentage obtained in step 1, enter the value on the abscissa of the graph in figure 7. Locate the corresponding point on the curve, and read across to find the volume ratio, R.

3. Determine:

$$V_T = (XA)/R$$

Where:

X = Maximum actuator travel from the appropriate actuator bulletin. For rotary actuators, substitute total displacement (XA). Actuator displacement can be found in the product bulletin, or contact your [Emerson sales office](#).

V_T = Minimum volume tank size required

R = Volume ratio from step 2

Note

Volume tank capacity values are nominal values only. Actual volume may vary slightly due to tolerances within the volume tank and supplier variability.

Installation

The 377 trip valve may be mounted in any position without affecting normal operation. Dimensions are shown in figure 8 and tables 1 and 2.

Table 1. Standard Volume Tank Dimensions⁽¹⁾

Tank Volume		J		L	
Liters	Inch ³ /Gal	mm	Inches	mm	Inches
11.8	721/3.1	309	12.16	318	12.5
21.6	1315/5.7	310	12.19	451	17.75
32.3	1970/8.5	309	12.16	595	23.43
42.9	2615/11.3	309	12.16	737	29.00
65.6	4001/17.3	309	12.16	1095	43.12
131.1	8002/34.6	Requires two 65.6 liter (4001 inch ³ /17.3 gal) volume tanks			

1. Volume tank capacity values are nominal values only. Actual volume may vary slightly due to tolerances within the volume tank and supplier variability.

Table 2. ASME-Approved, Canadian Registered Volume Tank Dimensions⁽¹⁾

Tank Volume		J		L	
Liters	Inch ³ /Gal	mm	Inches	mm	Inches
8.5	518/2.2	208	8.19	337	13.25
24.9	1520/6.6	305	12	427	16.81
30	1831/7.9	254	10	684	26.94
42.8	2609/11.3	305	12	681	26.81
68.8	4199/18.1	360	14.19	792	31.19
71.6	4371/18.9	305	12	1087	42.81
143.3	8742/37.86	Requires two 71.6 liter (4371 inch ³ /8.9 gal) volume tanks			
114	6930/30	406	16	965	38
227	13860/60	508	20	1219	48
303	18480/80	610	24	1600	63
454	27720/120	610	24	1702	67
908	55440/240	762	30	2134	87

1. Volume tank capacity values are nominal values only. Actual volume may vary slightly due to tolerances within the volume tank and supplier variability.

Figure 8. Dimensions of Trip Valve with Manifold (also see tables 1 and 2)

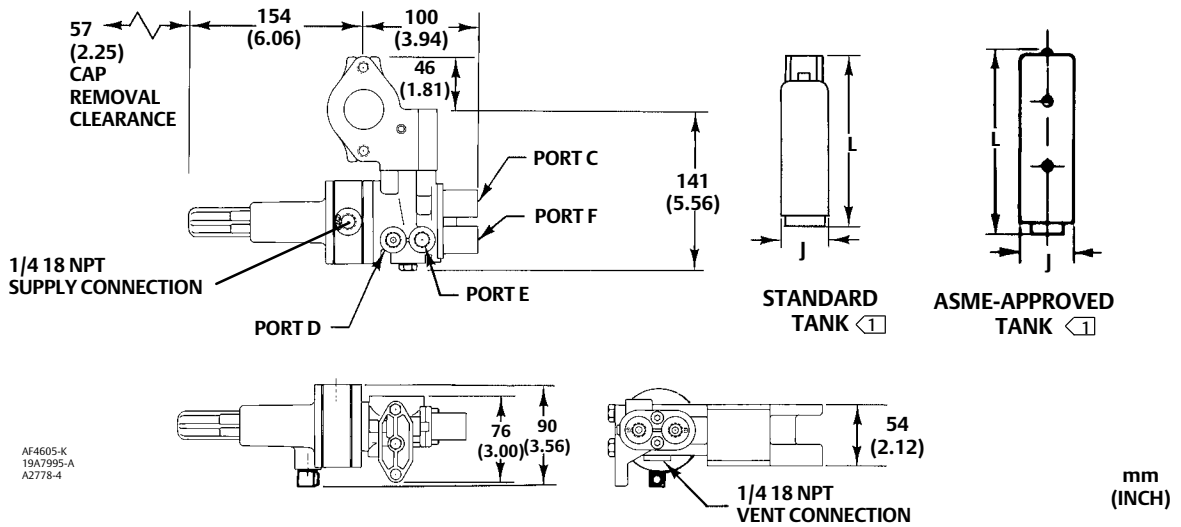

1) Refer to table 1 and 2 for J and L dimensions

Ordering Information

When ordering specify:

Application

1. Available supply pressure
2. Actuator type number and size
3. Aluminum or stainless steel construction
4. Input signal range
5. Operating ambient temperature
6. Trip point (If the trip point is not specified, the unit is factory-set to trip at 72 percent of supply pressure or 2.8 bar (40 psig), whichever is higher.)
7. Volume tank size

Trip Valve

Refer to the specifications. Review the information under each specification and in the referenced figures. Specify the desired choice wherever there is a selection to be made. Be sure to specify the type number as described in the Available Configurations specification.

Refer to table 3 for guidelines on specifying the correct trip valve.

Table 3. Guidelines for Specifying Fisher 377 Trip Valve

Actuator Type	Fail Mode	Valve Action ⁽¹⁾	Trip Valve
Sliding-Stem	Fail Open	PDTC	377U
		PDTO	377D
	Fail Closed	PDTC	377D
		PDTO	377U
Rotary: 1035 Bettis G Series	Fully Clockwise	Clockwise to Close	377CW
	Fully Counterclockwise		377CCW
Rotary: 1069	Fully Clockwise	---	377CW
	Fully Counterclockwise	---	377CCW

1. PDTC—Push Down to Close; PDTO—Push Down to Open

Neither Emerson, Emerson Automation Solutions, nor any of their affiliated entities assumes responsibility for the selection, use or maintenance of any product. Responsibility for proper selection, use, and maintenance of any product remains solely with the purchaser and end user.

Fisher and FIELDVUE are marks owned by one of the companies in the Emerson Automation Solutions business unit of Emerson Electric Co. Emerson Automation Solutions, Emerson, and the Emerson logo are trademarks and service marks of Emerson Electric Co. All other marks are the property of their respective owners.

The contents of this publication are presented for informational purposes only, and while every effort has been made to ensure their accuracy, they are not to be construed as warranties or guarantees, express or implied, regarding the products or services described herein or their use or applicability. All sales are governed by our terms and conditions, which are available upon request. We reserve the right to modify or improve the designs or specifications of such products at any time without notice.

Emerson Automation Solutions
Marshalltown, Iowa 50158 USA
Sorocaba, 18087 Brazil
Cernay 68700 France
Dubai, United Arab Emirates
Singapore 128461 Singapore

www.Fisher.com

